

Royal Lumos

14307171301 Mirror cabinet

PRODUCT



DRAWING

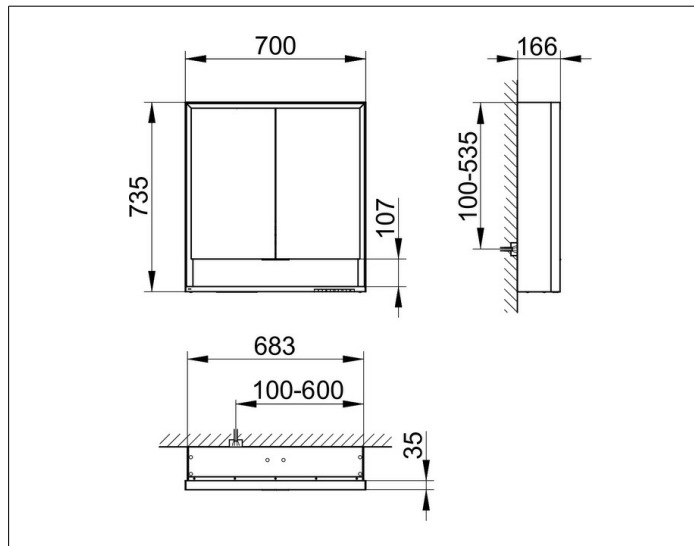

PRODUCT ATTRIBUTES

wall mounted,
 adjustable light colour from 2700 kelvin (warm white)
 to 6500 kelvin (daylight),
 2 hinged double sided crystal mirrored doors,
 Body: aluminium silver anodized
 Body panels made from rear-lacquered white glass
 interior rear wall mirrored
 Operation:
 key panel with capacitive touch sensor,
 integrated extension function for e.g. light switch
 Illumination:
 frame lighting and washbasin/shelf light separately,
 infinitely dimmable and can be switched on/off
 LED 55 watt (lifespan > 30.000 hours)
 infinitely dimmable
 EEK: C , 55 kWh/1000h

EQUIPMENT

- 2 sockets
- 2 x 2 adjustable glass shelves
- storage space across full width
- soft-closing doors

SURFACE

silver anodized

DIMENSION

700 x 735 x 165 mm