

Somaris

14502512131 Mirror cabinet

PRODUCT



DRAWING

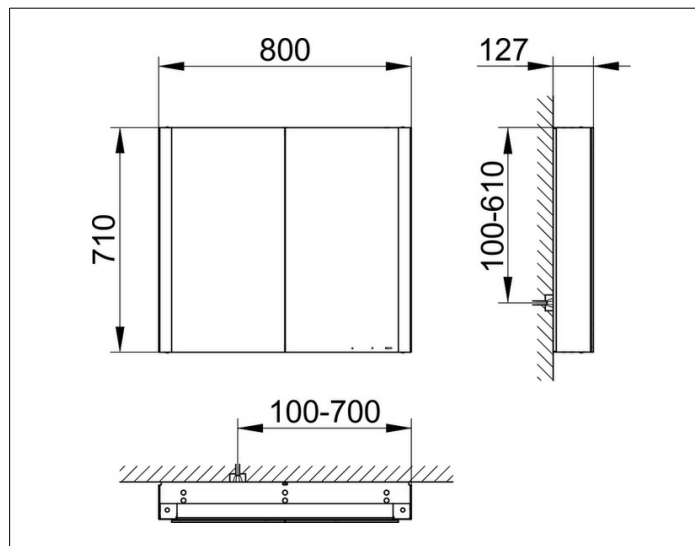

PRODUCT ATTRIBUTES

wall mounted,
 with mirror heating (placed in the centre of the door),
 2 hinged double sided crystal mirror doors,
 Body: aluminium silver anodized
 Rear panel made from HDF
 Operation:
 key panel with capacitive touch sensor,
 integrated extension function for e.g. light switch
 Mirror heating:
 60 watt, visual display of the heat up period,
 automatic switch-off is performed after 20 minutes
 Illumination:
 light colour 3000 kelvin (warm white),
 infinitely dimmable and can be switched on/off
 LED 25 watt (lifespan > 30.000 hours)

EQUIPMENT

- 1 shaver socket
- 3 adjustable glass shelves
- soft-closing door

SURFACE

white matt

DIMENSION

800 x 710 x 128 mm