

Edition 400

21512171351 Mirror cabinet

PRODUCT



DRAWING

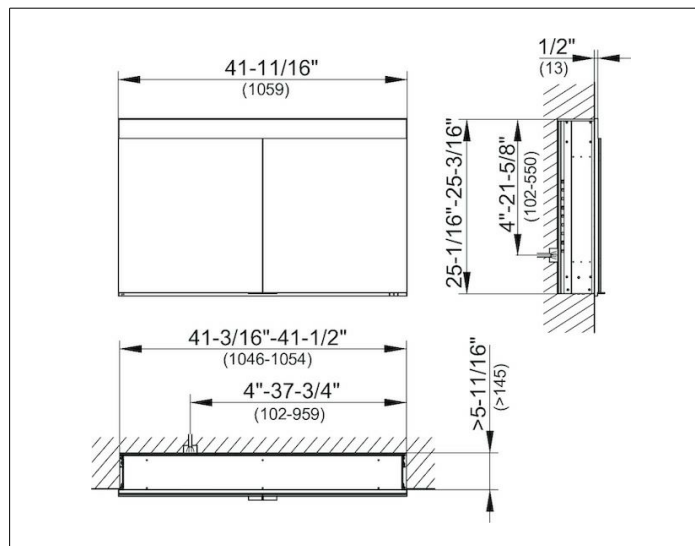

EEK: ,

SURFACE

silver anodized

DIMENSION

1060 x 650 x 154 mm

SPECIFICATIONS

KEUCO Edition 400 Mirror cabinet 21512171351
High quality Mirror cabinet in elegant design

for recessed installation,
1 light color, 4000 kelvin (neutral white)
2 hinged double sided crystal mirrored doors,
Body: aluminium silver anodized
interior rear wall mirrored

Operation:
key panel with capacitive touch sensor,
optional to be operated via the light switch

Illumination:
LED 39 watt (lifespan > 30.000 hours)
infinitely dimmable

- 2 sockets
- 2 x 3 adjustable glass shelves
- 2 storage boxes with slidable glass lid
- interior lighting
- soft-closing doors

41-3/4" x 25-9/16" x 6-1/16"

silver anodized