

Edition 11

31322WW0100 Side unit

PRODUCT

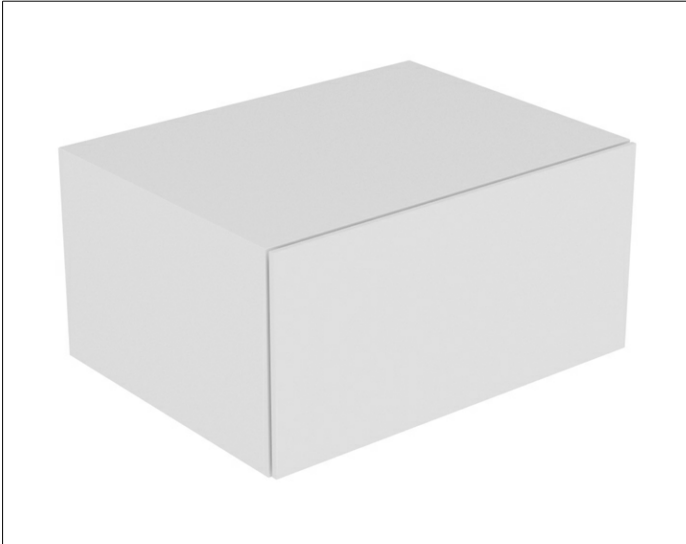

DRAWING

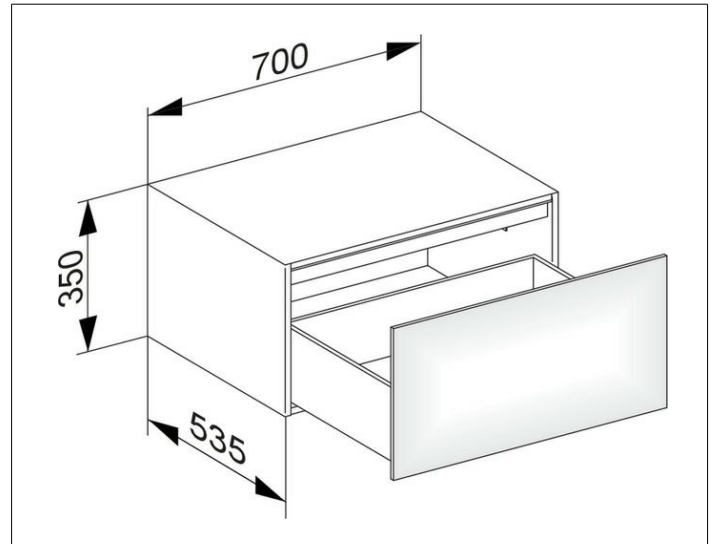

PRODUCT ATTRIBUTES

1 drawer front with push-to-open mechanism
with LED interior lighting, automatic on-off function
warm-white light colour

EQUIPMENT

- 1 sliding storage box (190 x 70 x 413 mm)

SURFACE

33

DIMENSION

700 x 350 x 535 mm