

Edition 11

31322XX0100 Side unit

**PRODUCT**

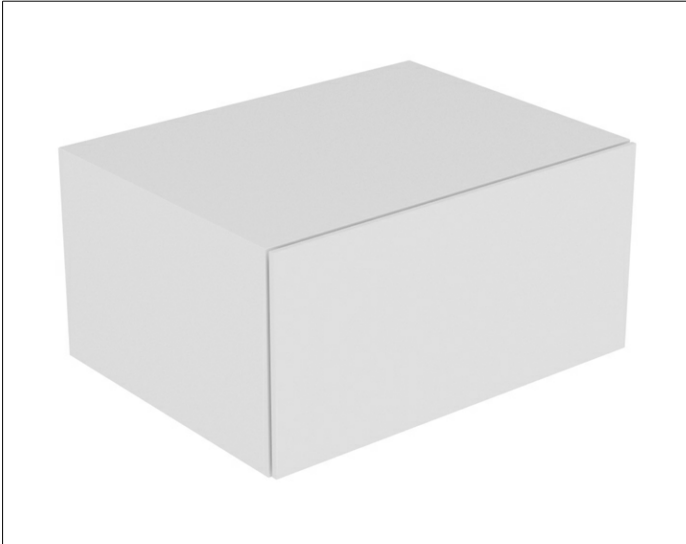

**DRAWING**

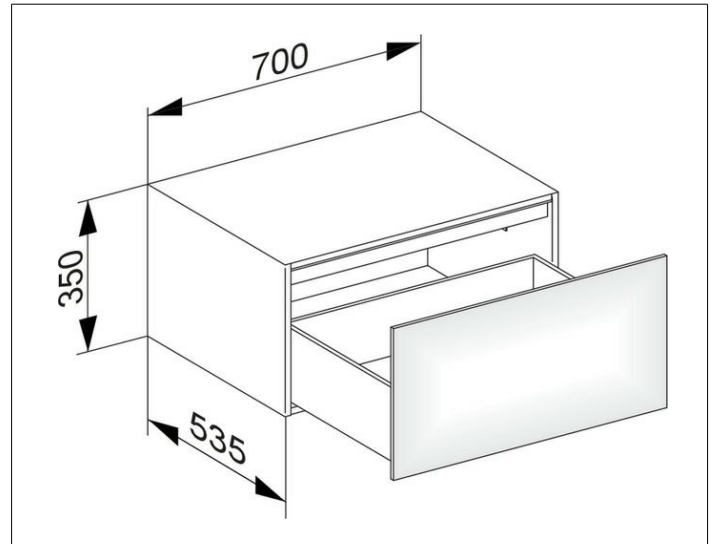

**PRODUCT ATTRIBUTES**

1 drawer front with push-to-open mechanism  
with LED interior lighting, automatic on-off function  
warm-white light colour

**EQUIPMENT**

- 1 sliding storage box (190 x 70 x 413 mm)

**SURFACE**

37, 38, 39

**DIMENSION**

700 x 350 x 535 mm