

AXESS

35014377013 Rail system

PRODUCT



DRAWING

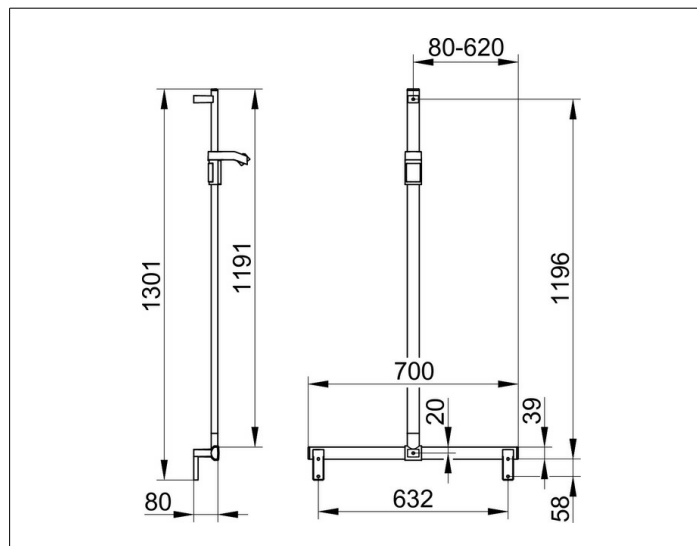

PRODUCT ATTRIBUTES

complete with hand-shower bracket, mountable on the right or left side, flexible positioning of sliding rail prior to final installation

SURFACE

black matt

DIMENSION

700/1301 mm

SPECIFICATIONS

KEUCO AXESS - Shower rail with hand shower sliding rail - 350 14 37 7013

Accessibility meets design

Shower handrail with shower rail and sliding bracket for shower head. Hand shower sliding rail freely positionable before mounting. The design impresses with its high ergonomic quality. The product is screwed on. Three concealed fastening.

Width / ø : 700 mm - Height: 1301 mm - Depth: 80 mm

Material: Metal

Surface: Black matt

Load capacity 115 kg

Included in delivery 2x mounting sets no 1.

Article no.: 350 14 37 7013