

Shower and shower accessories

53088070302 Arm for head shower DN 15

PRODUCT



DRAWING

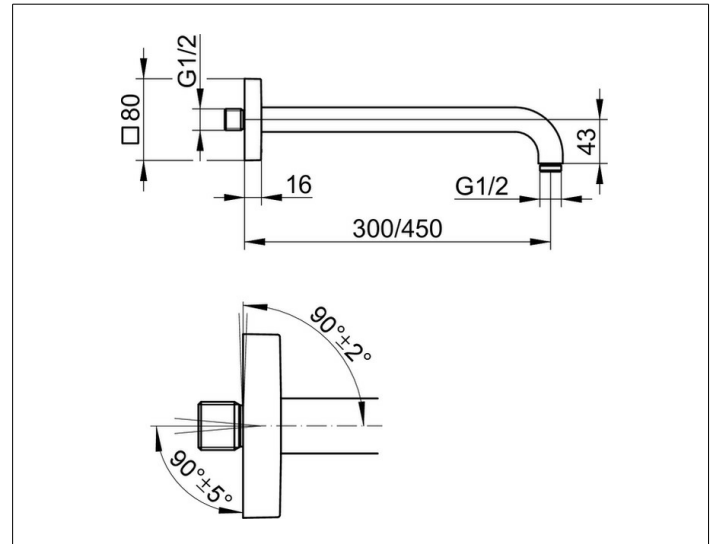

PRODUCT ATTRIBUTES

wall mounted G 1/2, with square decorative disc  
 Opportunity of alignment on the wall ( $90^\circ \pm 2^\circ$ ) and  
 wall connection ( $90^\circ \pm 5^\circ$ )

SURFACE

stainless steel finish

DIMENSION

Ausladung 300 mm