

Edition 90

59016010202 Single lever basin mixer

PRODUCT

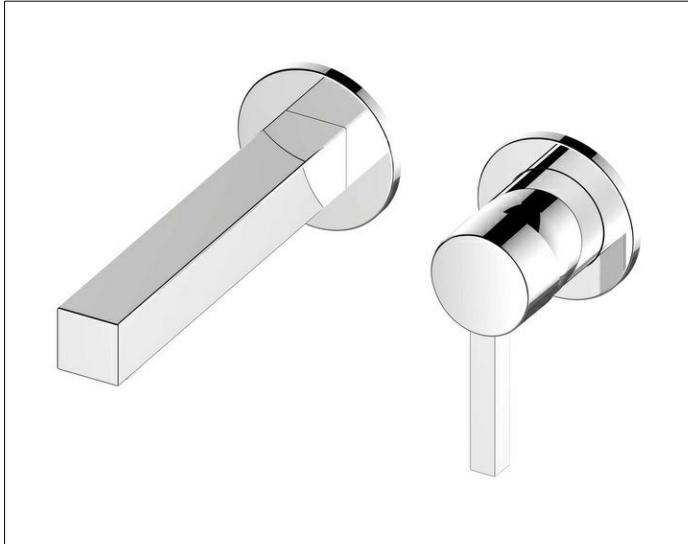

DRAWING

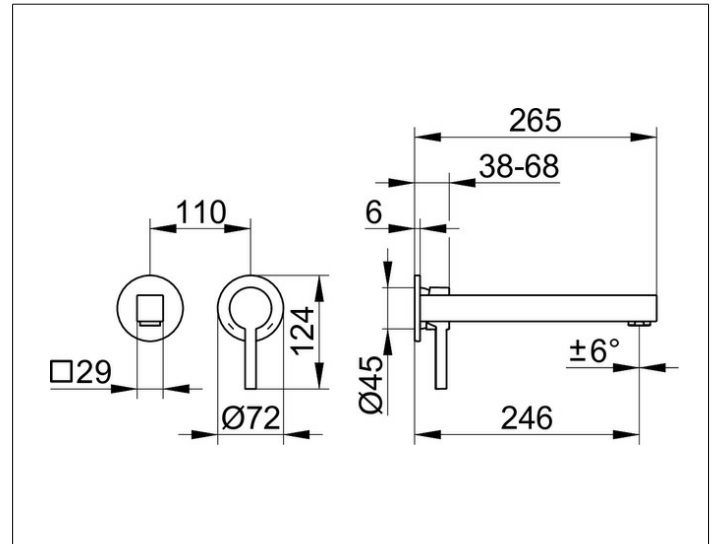

PRODUCT ATTRIBUTES

concealed, DN 15,
 mixing cartridge with ceramic sealing gaskets
 temperature controlled
 aerator M 24x1, adjustable,
 flow rate limited to 7,6 l/min.
 in combination with rough part 59916 000070

SURFACE

chrome-plated

DIMENSION

Ausladung 246 mm