

Plan

33097 XX1050 07897 171050

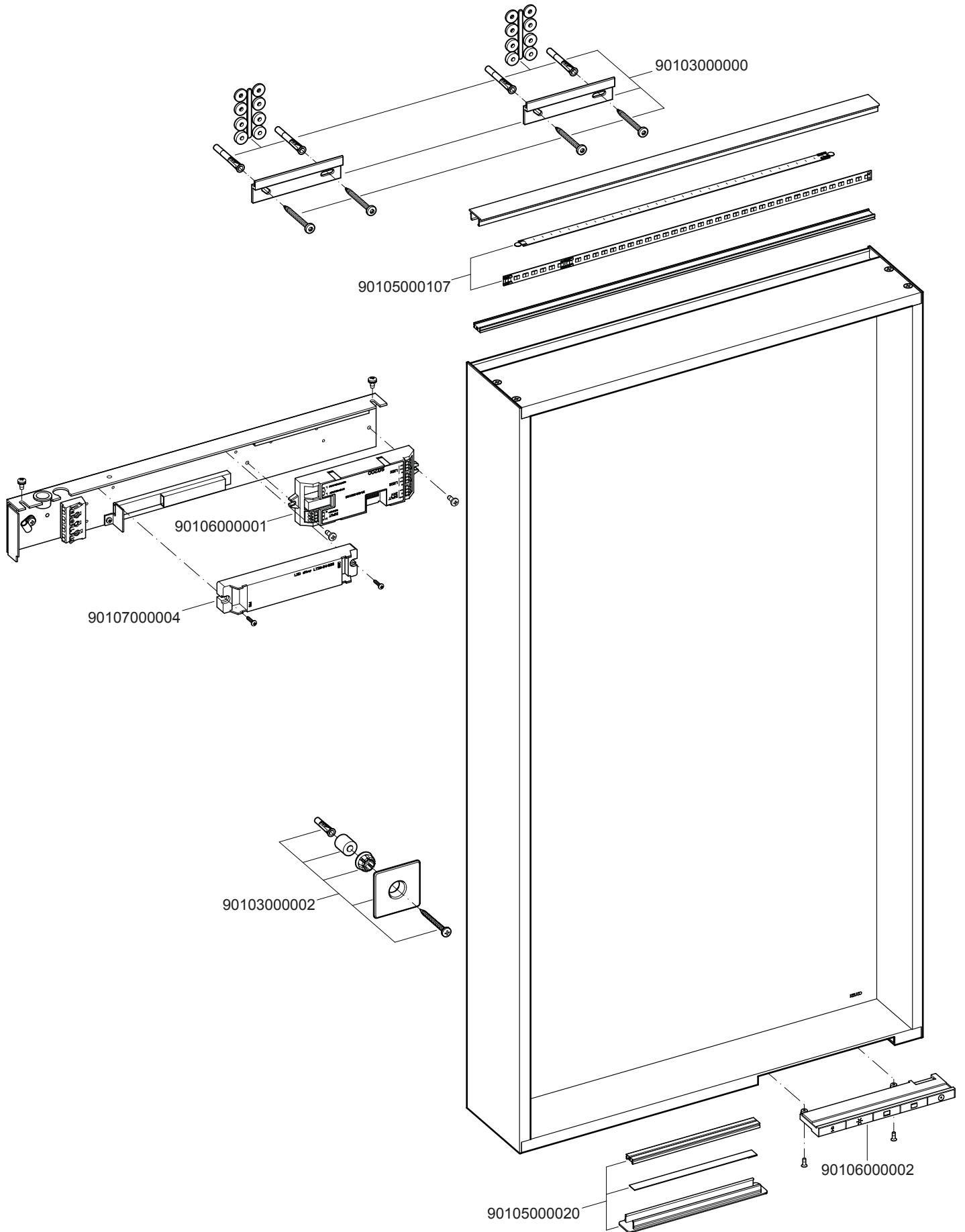

XX = 11, 14, 18, 29, 30